



**Model Number**

**V11-W-BK1,5M-PUR-U-V11-G**

Connection cable, M12, 3 pin, PUR cable

**Features**

- UL Recognized Component
- Knurled nut suitable for tool assembly
- Immunity to vibration, with mechanical latching
- Gold plated contacts
- Halogen-free
- Degree of protection IP67 / IP68 / IP69K
- Suitable for drag chains

**Dimensions**

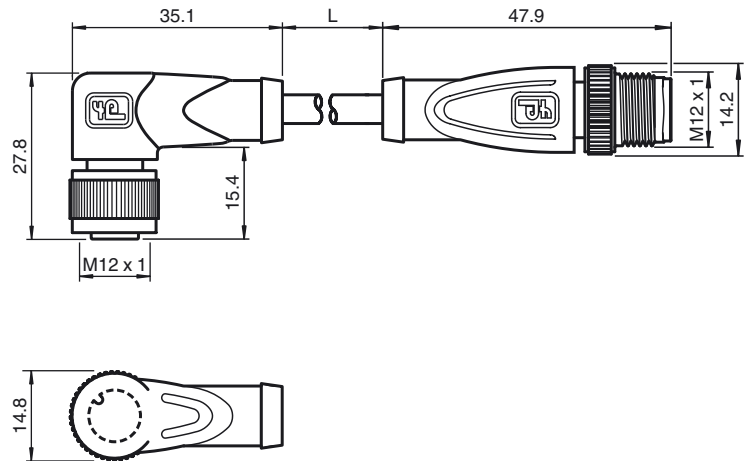

**Technical data**

**General specifications**

Number of pins	3
UL File Number	E231213

**Electrical specifications**

Operating voltage	$U_B$	max. 300 V DC
Operating current	$I_B$	max. 4 A
Volume resistance		< 5 mΩ

**Ambient conditions**

Ambient temperature	-25 ... 100 °C (-13 ... 212 °F) for temperatures over 80 °C (176 °F) reduced elongation at tear
Pollution degree	3

**Mechanical specifications**

Contact elements	spring-loaded contact socket
Pin diameter	1 mm
Degree of protection	IP67 / IP68 / IP69k
Cable code	Li 9Y 11Y 3 x 0.34

**Material**

Contacts	CuSn / Au
Contact surface	Au
Body	TPU, black
Cable	PUR
Slotted nut	Diecast zinc
Sleeve connector	Diecast zinc
Core insulation	PP
Cable	extra-fine wire, flexible
Sheath diameter	Ø 4.3 mm
Bending radius	> 10 x cable diameter, moving > 5 x cable diameter, fixed

Color	black
Number of cores	3
Core cross-section	0.34 mm <sup>2</sup>
Conductor construction	42 x 0.1 mm Ø
Length	L 1.5 m

**Drag chain suitability**

Drag chain cycles	≥ 5000000
Motion velocity	≤ 3.3 m/s
Acceleration	≤ 5 m/s <sup>2</sup>
Torsional stress	± 180 °/m

**Flammability**

Contact carrier	94 V-2
Housing	94 V-2
Cable	FT2

**Approvals and certificates**

**Electrical connection**

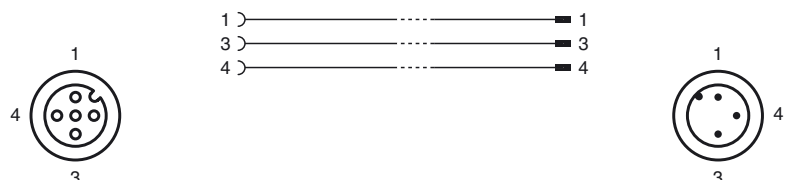

Release date: 2017-06-21 09:29 Date of issue: 2017-06-21 219117\_eng.xml



UL approval

cURus AWM 20549 AWM I/II A/B 80°C 300V FT2 (cable)

Release date: 2017-06-21 09:29 Date of issue: 2017-06-21 219117\_eng.xml